

Instructions for assembling furniture Instrukcja montażu mebli

Collection Kolecja mebli
«WHITEBLACK»

Regał 1D1S
Cupboard 1D1S

AH-071.08.00.00

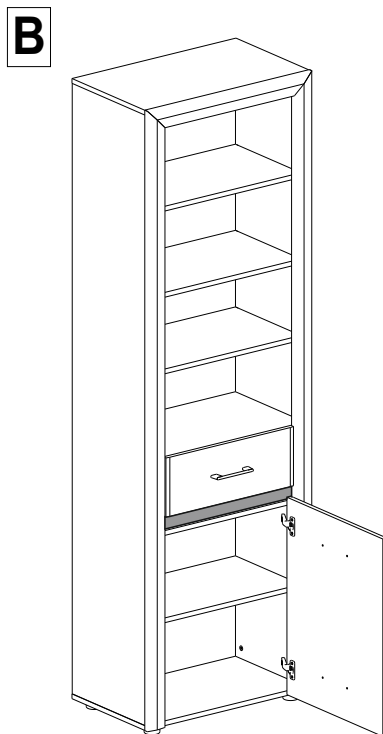
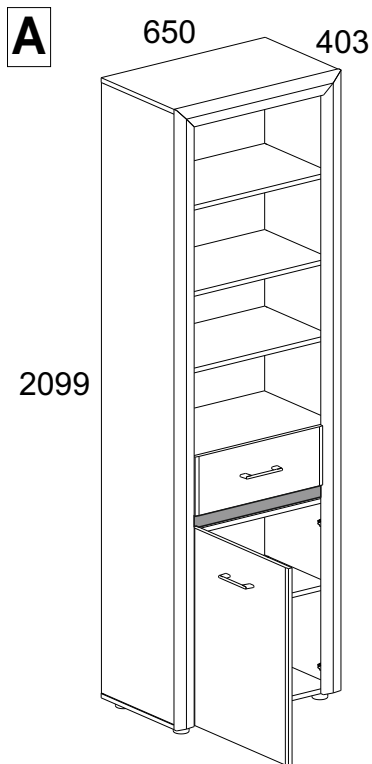

Production date
Data produkcji

Stamp of Quality Department
Pieczęć Działu Jakości

PL**Przy eksploatacji mebli zabrania się:**

- ustawiać meble w pobliżu grzewczych przyrządów i obok wilgotnych ścian, a także w pomieszczeniach ze względną wilgotnością więcej niż 70%;
- temperatura nagrzewania elementów mebli nie może przekraczać +40°C;
- w trakcie montażu i eksploatacji mebli stawać nogami na poziome panele i witryny;
- stosować chemiczne środki czyszczące do sprzątania mebli;
- nie należy narażać na kontakt z wodą.

Gwarancje producenta.

1. Gwarancyjny termin eksploatacji wyrobu - 24 miesiące z dnia sprzedaży. W okresie gwarancyjnego terminu producent gwarantuje naprawę wyrobów lub ich zamianę, jeżeli reguły eksploatacji nie zostały naruszone przez nabywcę.
2. Roszczenia są przekazywane przez nabywcę bezpośrednio do handlującej organizacji, w której były nabyte meble, tylko przy okazaniu danej "Instrukcji montażu" wraz z dokumentem zakupu.
3. Wyrób **Regał 1D1S**, wchodzące w zestaw mebli „**WHITEBLACK**”, odpowiada wymaganiom Norm Państwowych 16371-2014, TP TC 025/2012.
4. Trwałość użytkowa mebli - 5 lat.
5. Firma-producent pozostawia za sobą prawo do wprowadzania zmian w konstrukcje wyrobów, nie pogarszając ich konstruktywne i eksploatacyjne charakterystyki.
6. Do montażu wyrobów zaleca się skorzystanie z pomocy wykwalifikowanych specjalistów.

Zapach.

Nowe meble mogą wydzielać zapach materiałów, z których są wykonane. Zapach może utrzymywać się do trzech tygodni od momentu montażu. Aby zmniejszyć intensywność zapachu, zaleca się:

- w przypadku mebli tapicerowanych - odkurzyć produkt i przewietrzyć pomieszczenie. Powtarzaj 3-4 razy dziennie.
- dla mebli szafkowych - przetrzyj ściereczką zwilżoną łagodnym detergentem, przetrzyj czystą, suchą ściereczką i przewietrz pomieszczenie, uprzednio otwierając wszystkie drzwi i szuflady produktu. Powtarzaj 3-4 razy dziennie.

Ważne! Proszę zachować instrukcję w razie ponownego montażu mebli lub reklamacji. Podczas składania reklamacji prosimy o korzystanie z oznaczeń z instrukcji.

EN**Instruction manual.**

It's advised to check the quality and completeness of the product in the store when buying unpacked. Assembling of the product should be done the way it's described in this manual. While the product is in service loose screw connections should be periodically tightened. If it's necessary to move items around the apartment before moving you should release the product completely from the load (the mattress). To prevent damage to existing supports the product should be lifted before moving. Furniture should not be exposed to contact with water. Dusting the product should be done with a slightly damp soft cloth. To prevent warping of parts and discoloration of products do not install furniture in direct sunlight.

While the product is in service it's PROHIBITED TO:

- Install furniture near heating devices, close to the raw walls and in rooms with a relative humidity of more than 70%;
- heat elements of furniture to the temperature higher +40°C;
- step on the horizontal shields and windows during assembly and use of the products set;
- use chemical cleaners for cleaning furniture;

Manufacturer's warranty.

1. The warranty period of use of the product - 24 months from the date of sale. During the warranty period the manufacturer guarantees repair or replacement of products, if the user has not violated operating rules.
2. Claims should be made by the consumer directly to the trading organization, in which furniture was purchased, presenting the "Instruction manual" and a copy of the sales receipt.
3. The product **Cupboard 1D1S**, which is part of a set of „**WHITEBLACK**”, meet the requirements of GOST 16371-2014, TR TS 025/2012.
4. The lifetime of furniture - 5 years.
5. The manufacturer reserves the right to make changes in product design, without compromising its design and application requirements.
6. To assemble the products it's recommended to attract qualified personnel.

Smell.

New furniture may emit the smell of the materials from which it is made. The smell can persist for up to three weeks from the time of assembly. To reduce odor intensity, it is recommended:

- for upholstered furniture - vacuum the product and ventilate the room. Repeat 3-4 times a day.
- for cabinet furniture - wipe with a cloth dampened in a mild detergent, wipe with a clean, dry cloth and ventilate the room, previously opening all doors and drawers of the product. Repeat 3-4 times a day.

It is important! Keep the instruction in case of reassembly of furniture or complaint. When making a claim use the notation from the instruction.

№	L, mm	B, mm	H, mm	Q	№ pack
1	648	384	16	1	2/3
30	648	384	16	1	2/3
51	614	364	16	1	2/3
71	614	344	16	4	1/3
93	2041	384	16	1	2/3
94	2041	384	16	1	2/3
120	650	70	19	1	2/3
133	2074	70	19	1	2/3
134	2074	70	19	1	2/3
153	364	110	16	1	2/3
154	364	110	16	1	2/3
166	504	198	16	1	1/3
176	320	100	16	1	1/3
177	320	100	16	1	1/3
186	434	100	16	1	1/3
209	660	504	16	1	1/3
251	614	60	24	1	1/3
252	614	60	16	2	1/3
283	1171	626	2,5	1	3/3
284	882	626	2,5	1	3/3
311	464	325	2,5	1	1/3

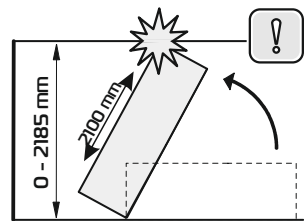
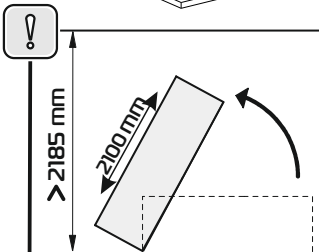
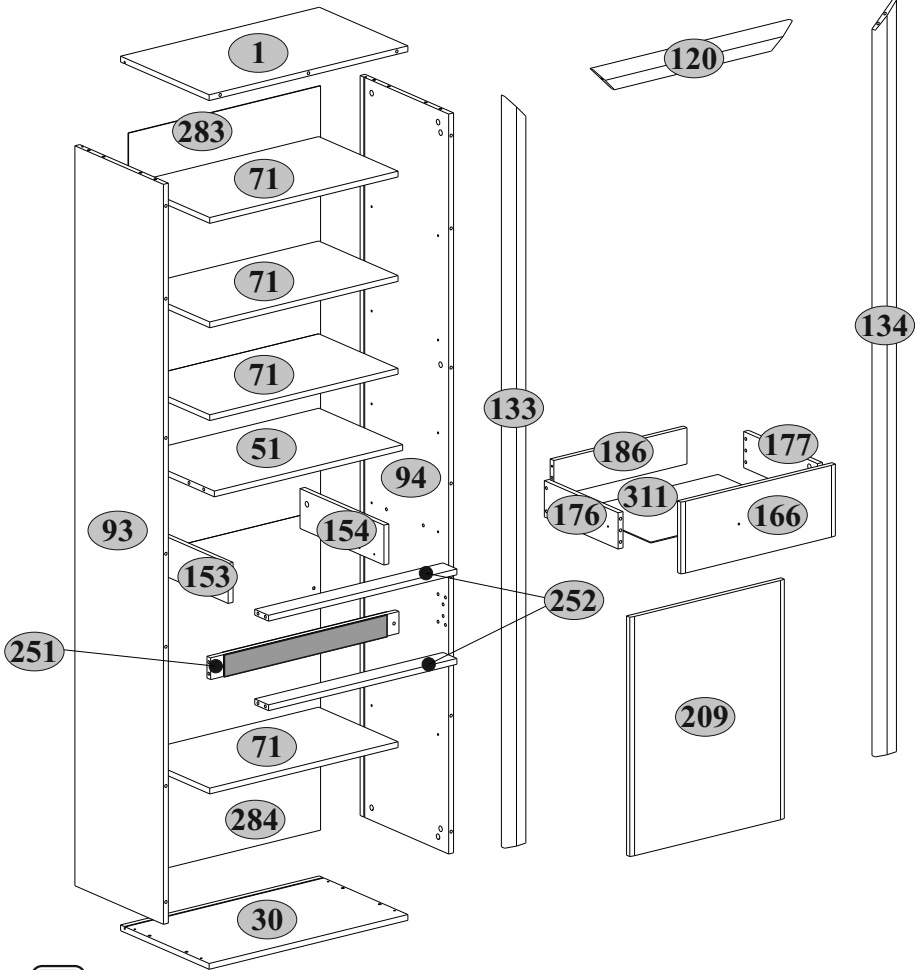
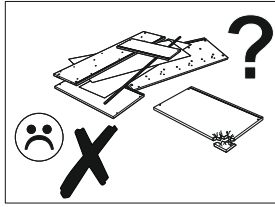

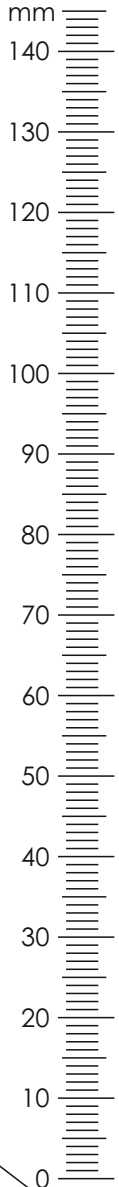

A1 7x34 30	A2 Ø15x12 34	A9 L=47,4 2	B5 10x50 1
C1 8x35 41	D1 2	E2 2	H49 2
I S4 1	M12 M4x25 4	N13 4	P5 16
Q 1,5x7 1	R3 3x20 11	R23 6,3x13 4	R24 7x50 4
R27 5,0x13 10	R39 3,5x25 4	R102 3,5x16 6	S1 16
S5 Ø18 20	S3 3	S11 Ø8 2	U 130x35x15 1

Dodatkowe elementy do zakupu (O2, O27)*
Additional element for buy (O2, O27)*

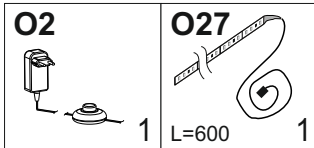

11
20

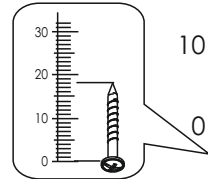
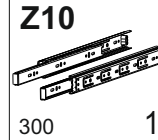

*Montaż taśmy LED podczas montażu obudowy
*Installing the LED strip when installing the housing

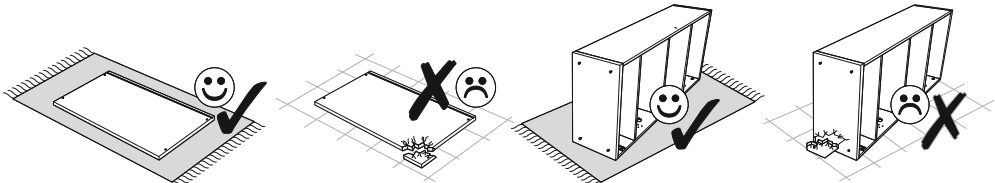

1

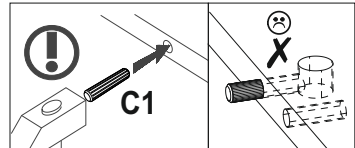
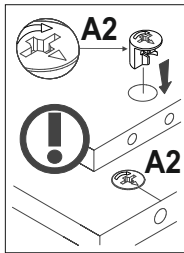
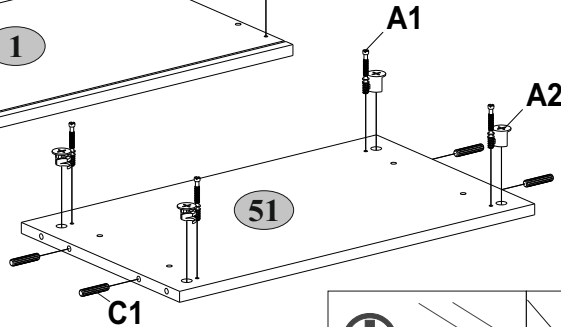
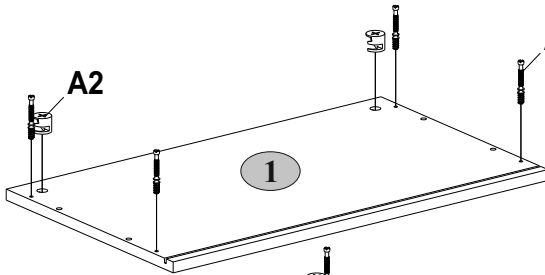
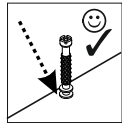
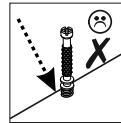
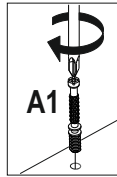
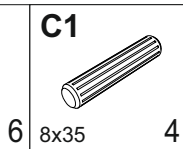
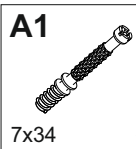

2

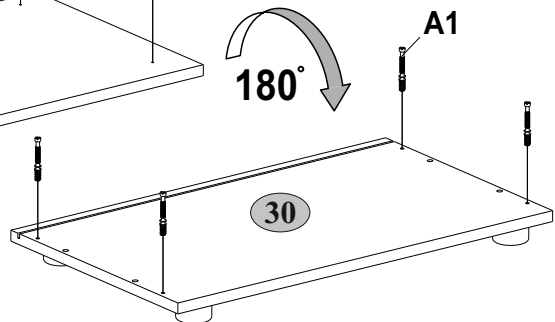
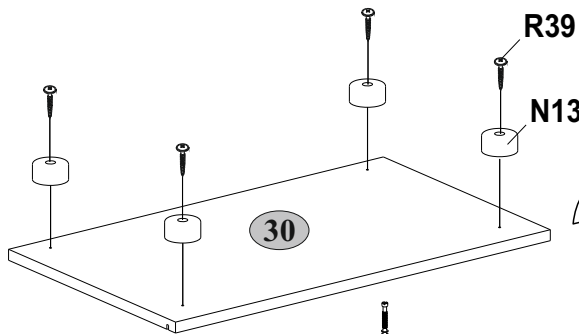
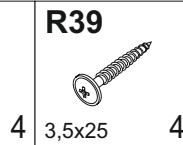
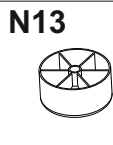
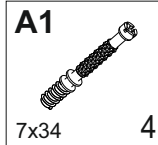

3**A2**

Ø15x12

4

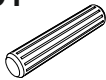
C1

8x35

4

R27

5,0x13

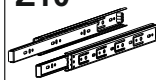
Z10

6 300

1

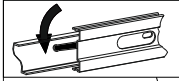
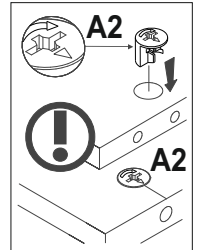
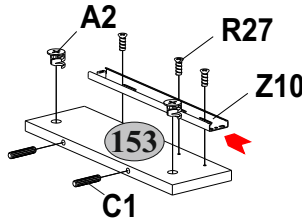
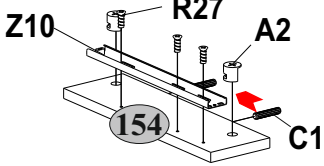
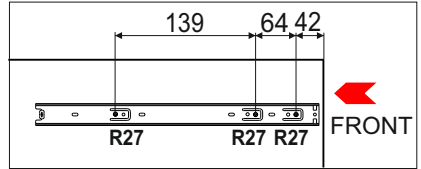
**Z10****I****II****4****A1**

7x34

A2

4

Ø15x12

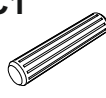
C1

16 8x35

P5

8

16

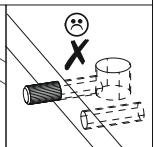
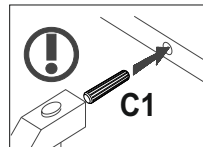
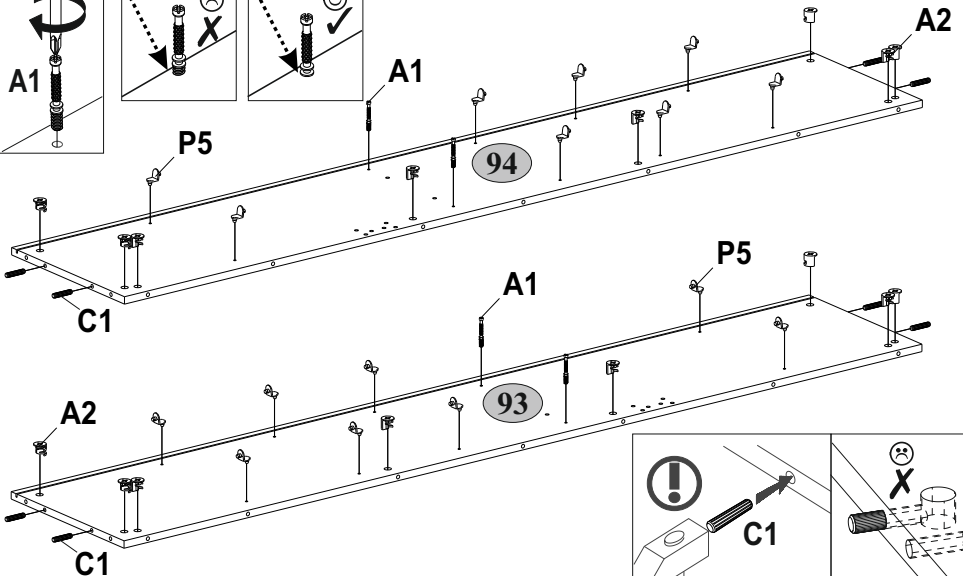
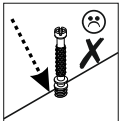
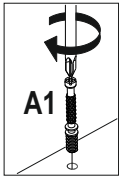

5

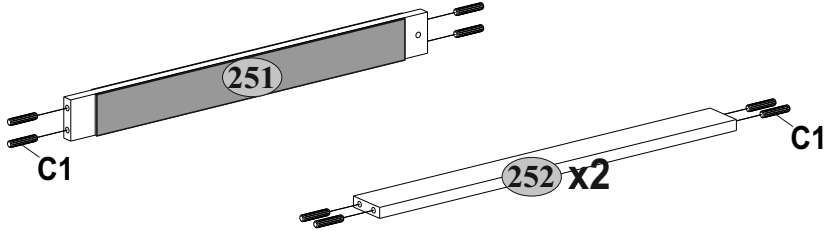
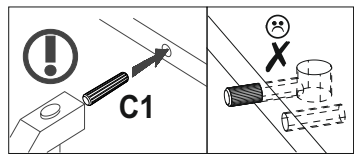
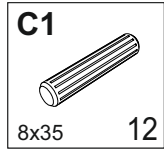

6

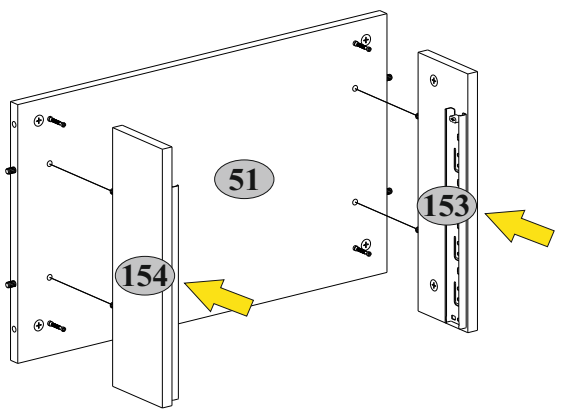

7

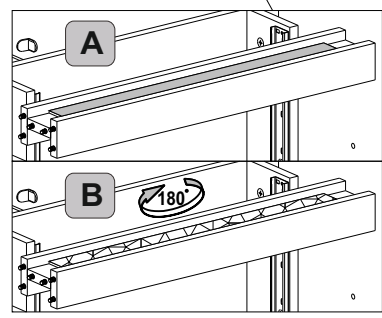
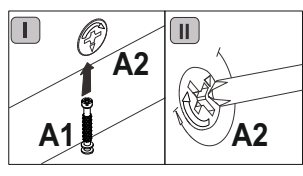
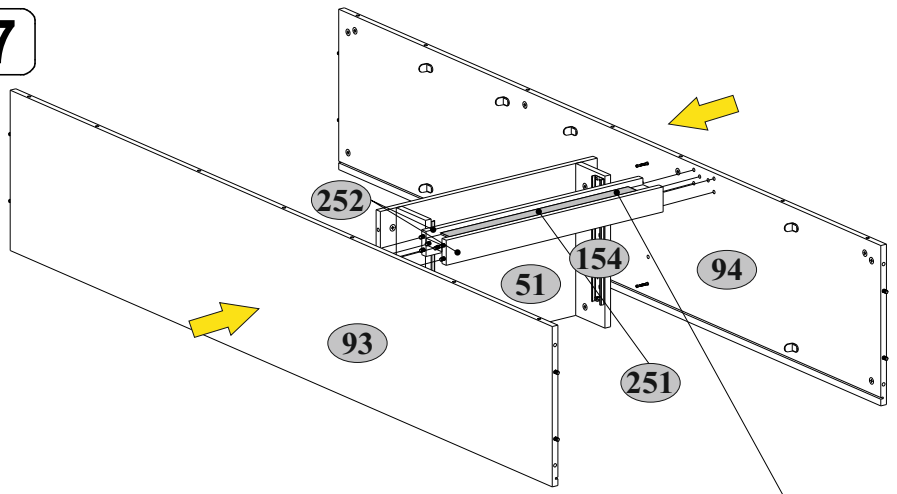

8

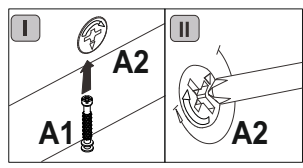
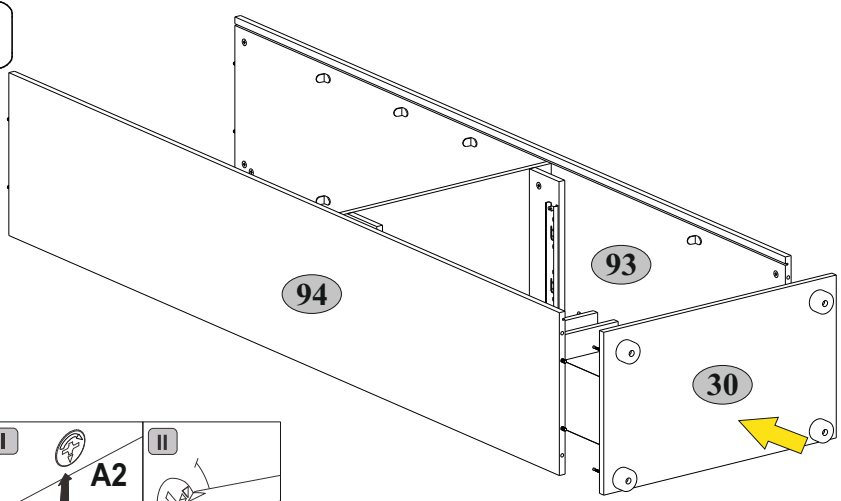

9

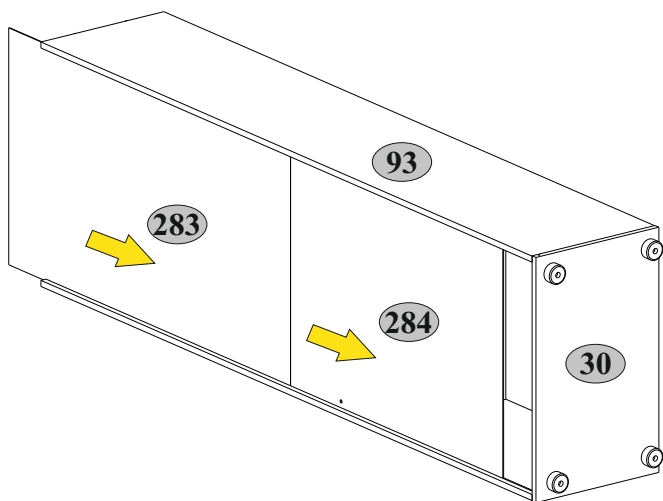

10

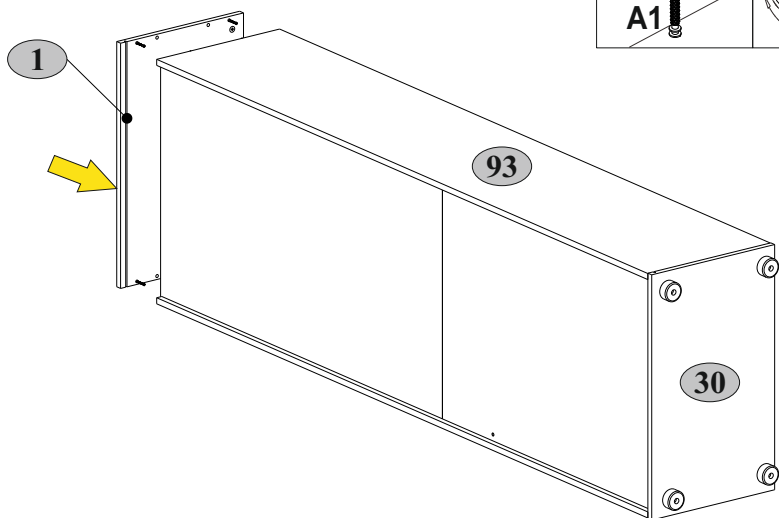

11

O27

L=600

1

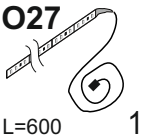

1



2



!

3

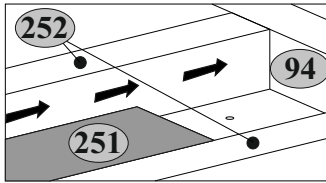
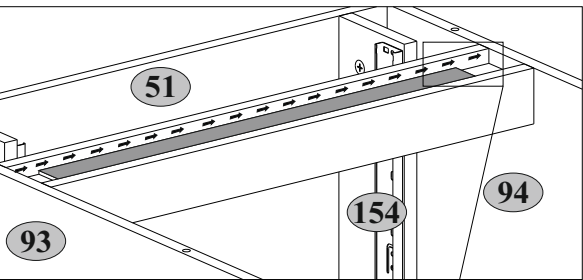

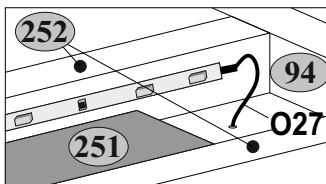
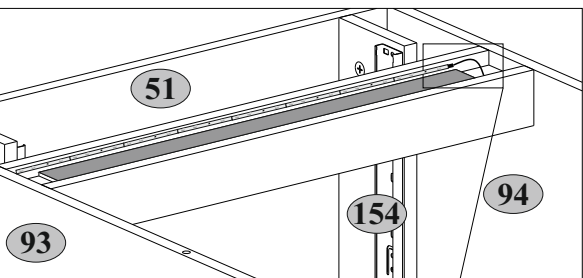
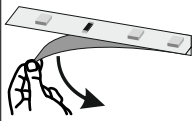

!

4

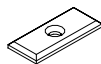

12

R3  3x20 3	S1  16 3	S3  3 3
---	---	--

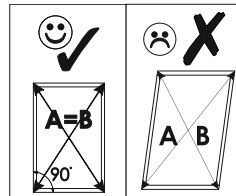

A=B

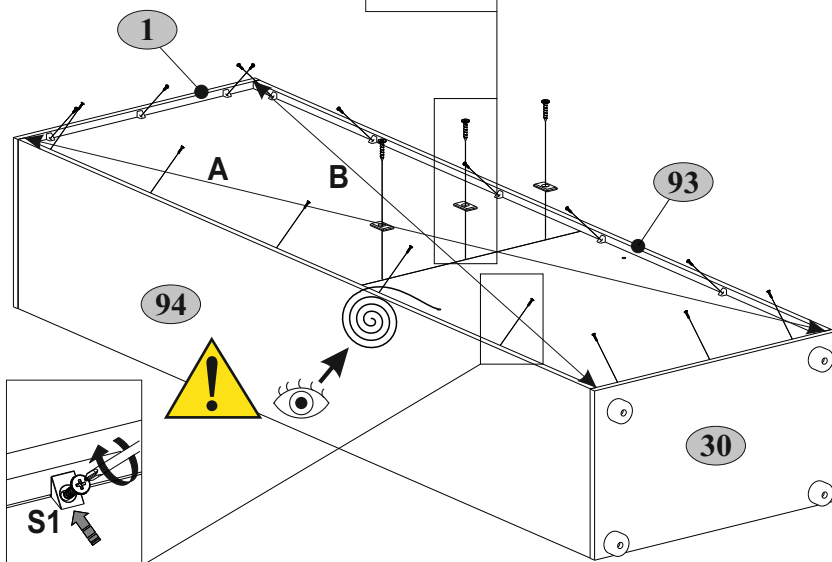
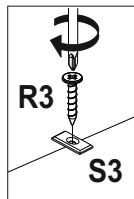
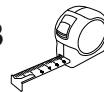

13**A1**

7x34

10

A2

Ø15x12

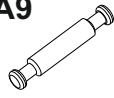
A9

4 L-47,4

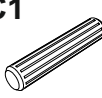
C1

2 8x35

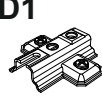
D1

2

2

R23

6,3x13

4

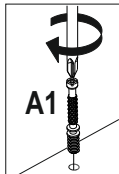
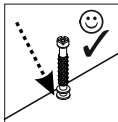
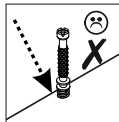
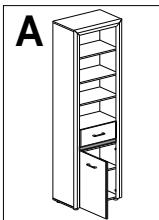

4

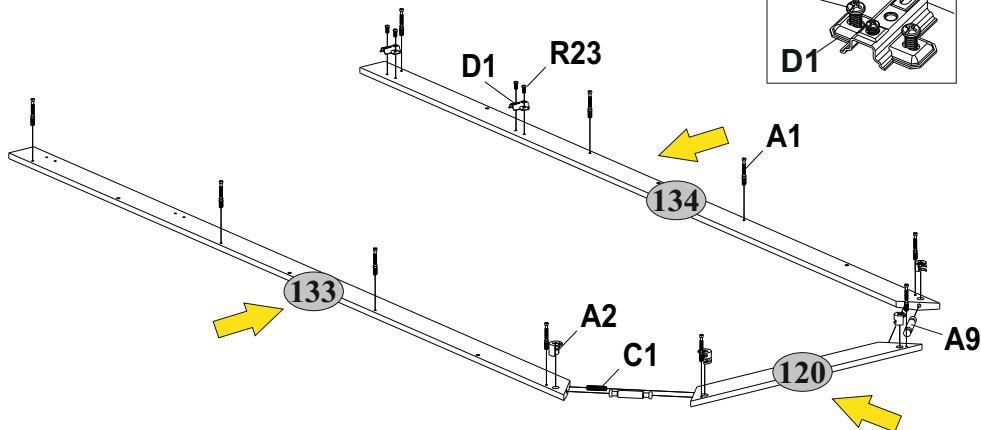
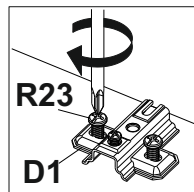
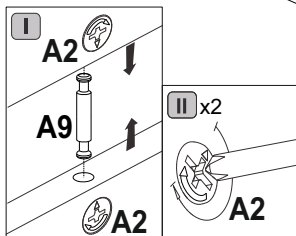
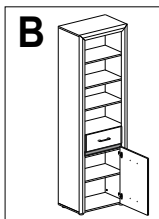
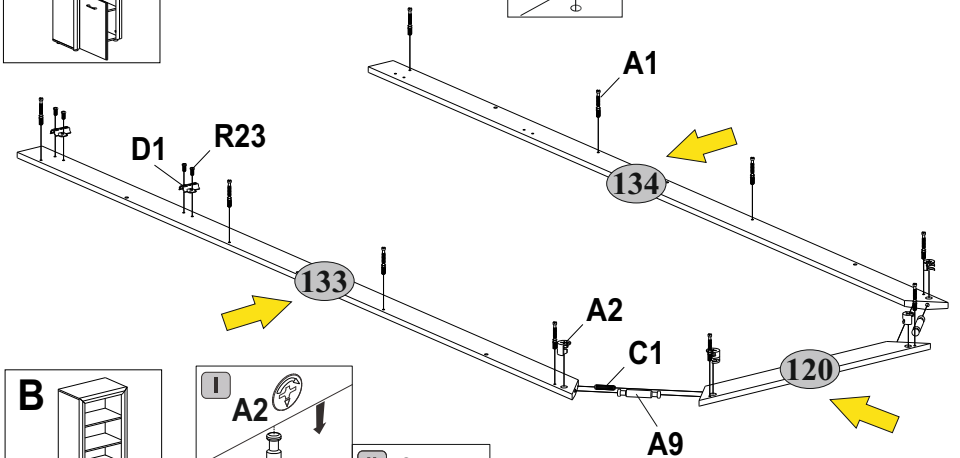



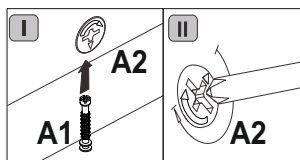
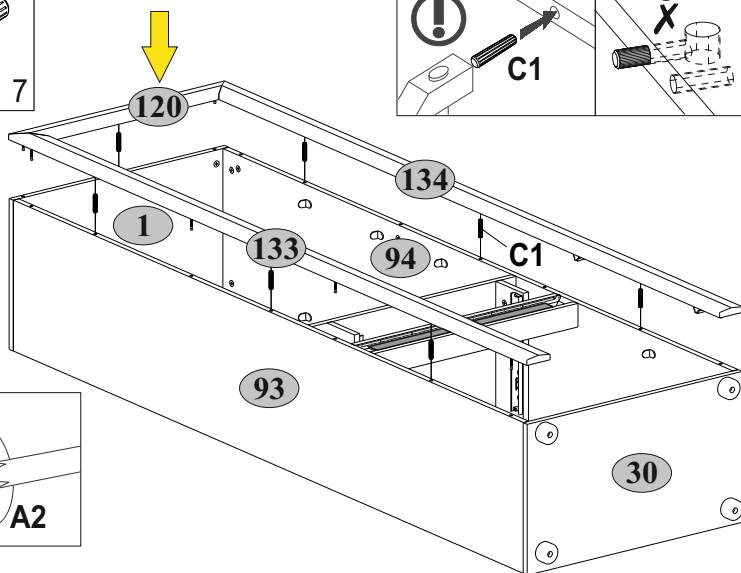
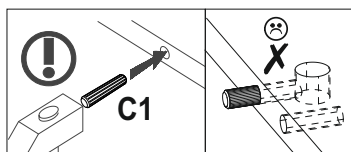
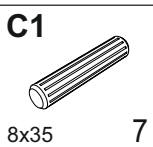

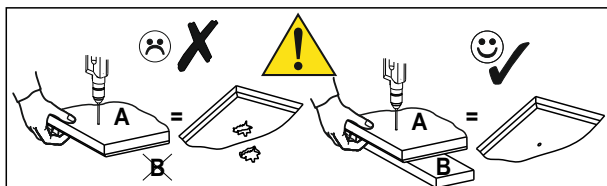
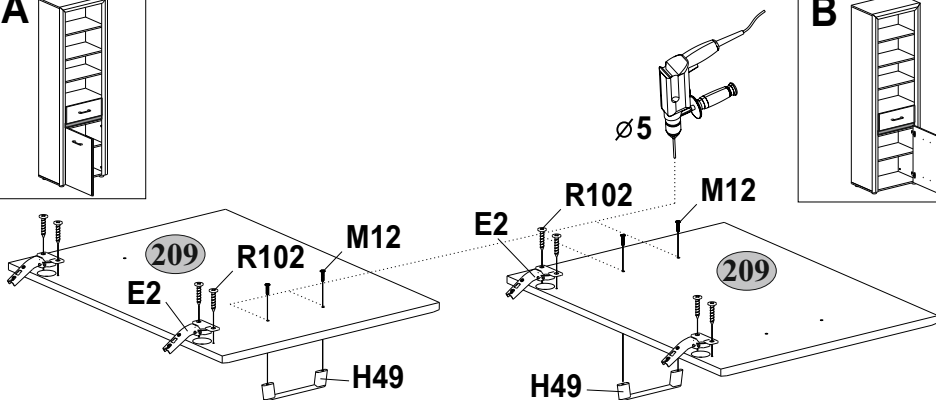
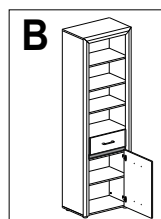
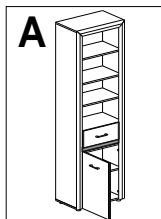
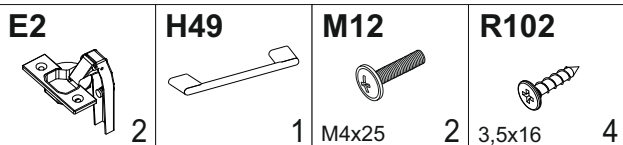

14



15

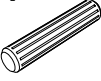
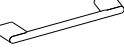

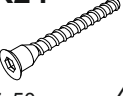
16

A1  7x34 4	A2  Ø15x13 4	C1  8x35 4	H49  1	I  S4 1
M12  M4x25 2	R24  7x50 4	R27  5,0x13 4	Z10  300 1	

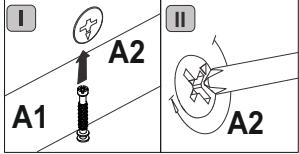
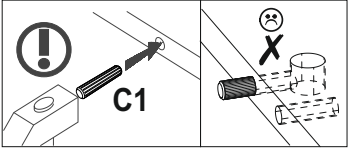
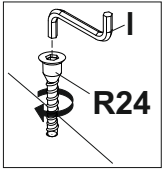
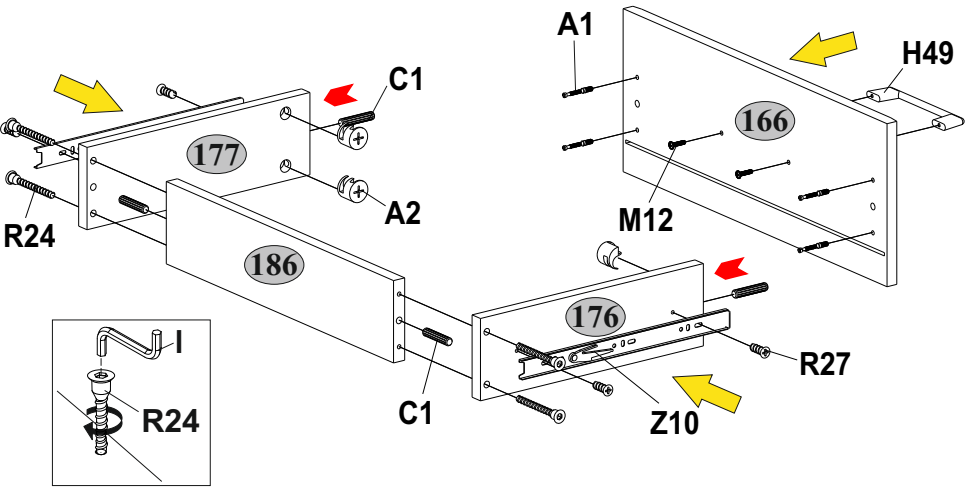
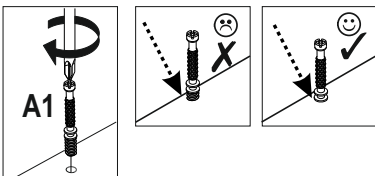
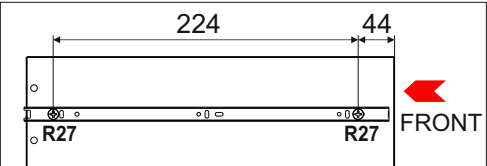
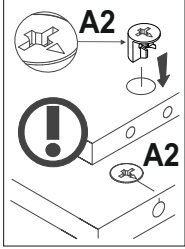

17

R3

3x20

8

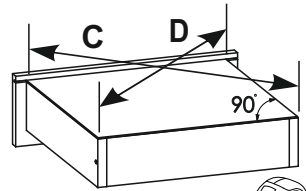

C=D

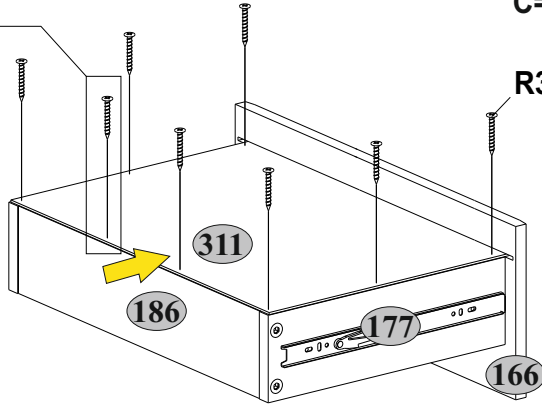
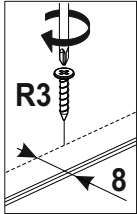
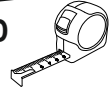

18

S5

Ø18

20

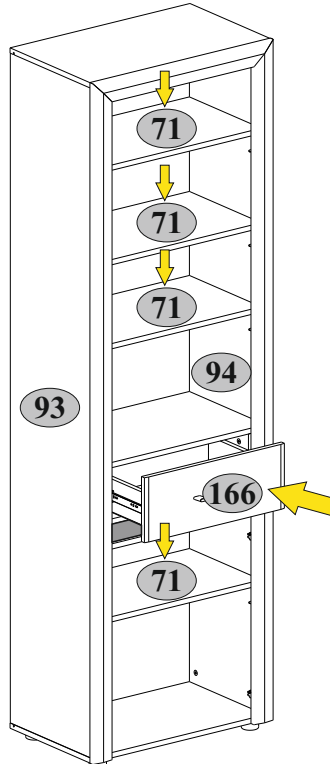
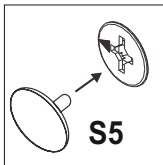

19**B5**

10x50

1

Q

1,5x7

1

R102

3,5x16

2

S11

Ø8

2

U

130x35x15

1

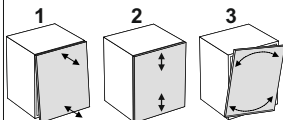
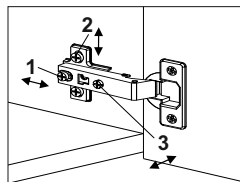
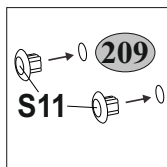
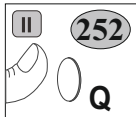
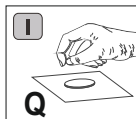
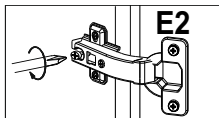
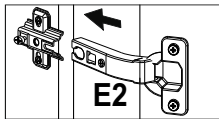
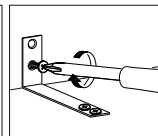
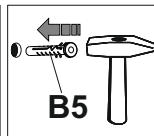
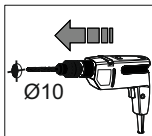
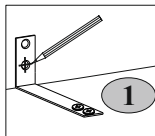
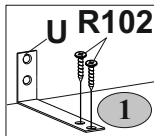
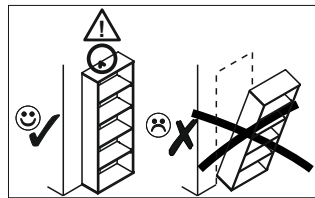
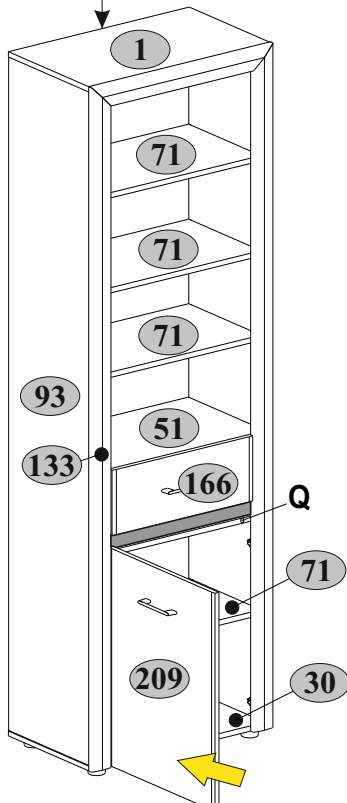
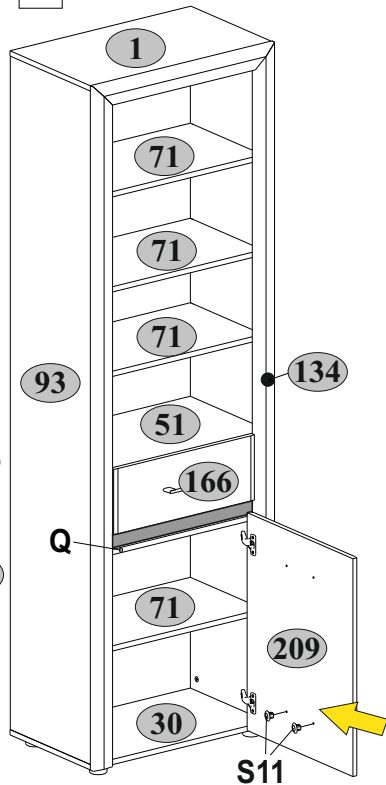
**A****B**

30 51
71 166

max. 5 kg

20

O2

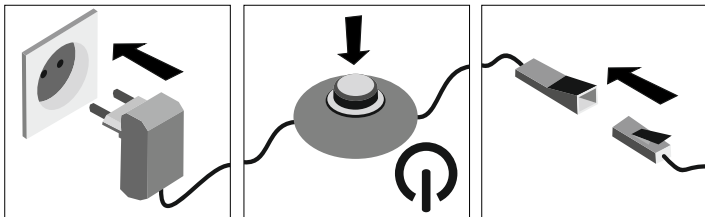
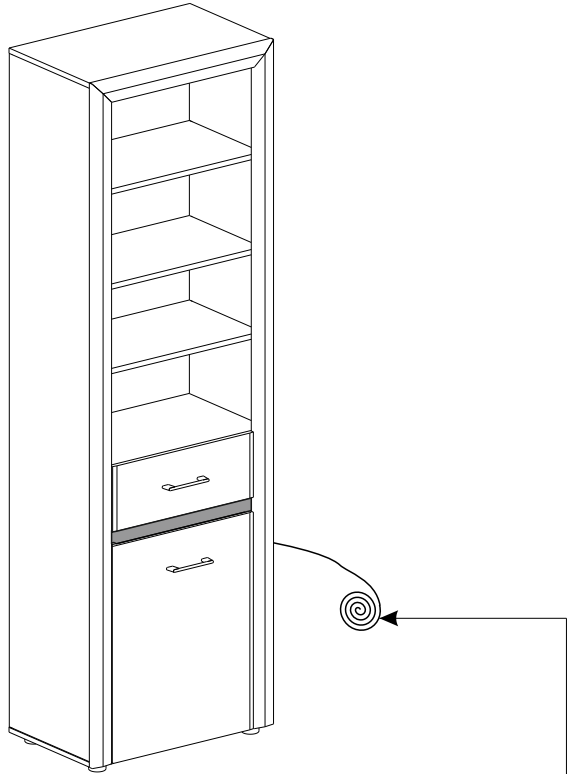
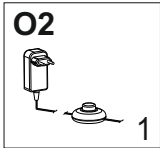

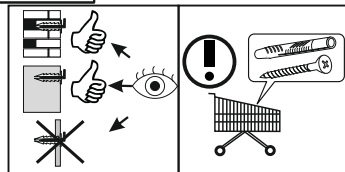
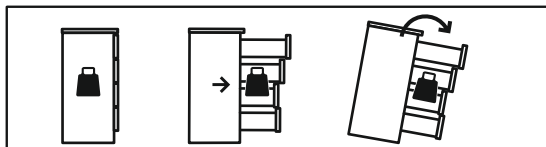

PL

OSTRZEŻENIE!

Przewrócenie się mebla może spowodować poważne lub śmiertelne obrażenia ciała na skutek przygniecenia.

ZAWSZE przymocuj ten mebel do ściany za pomocą ograniczników.

Kołek osadzony stosuje się do ścian z cegły i betonu. Do montażu na ścianie użyj łączników odpowiednich do materiału, z którego wykonana jest ściana, jeśli nie masz pewności, który rodzaj mocowania jest odpowiedni dla materiału ściennego, skontaktuj się ze specjalistą lub specjalistycznym sklepem. Ostatecznie za elementy złączne odpowiedzialny jest instalator.

Aby dodatkowo ograniczyć ryzyko poważnych obrażeń ciała i śmierci na skutek przewrócenia się mebla:

- Najcięższe przedmioty umieść w dolnej szufladzie.
- Nie kładź na wierzchu ciężkich przedmiotów.
- Nigdy nie pozwalaj dzieciom wspinać się na szuflady, drzwiczki lub półki.
- Używaj mebli zgodnie z ich przeznaczeniem.

EN

WARNING!

Serious or fatal crushing injuries can occur from furniture tip-over.

ALWAYS secure this furniture to the wall using tip-over restraints.

The embedded dowel is used for brick and concrete walls. For wall mounting, use fasteners suitable for the wall material of your home, if you are not sure which type of fastening is suitable for the wall material, contact a specialist or a specialized store. Ultimately, the installer is responsible for the fasteners.

To further reduce the risk of serious injury and death from tip-overs:

- Place heaviest items in the lower drawer.
- Do not heave objects on top of this product.
- Never let children climb or hang on drawers, doors, or shelves.
- Use the furniture for its intended purpose.